

STANDARD EQUIPMENT

- ENGINE**
- Engine, HINO J05E-TA, Diesel engine with turbocharger and intercooler
 - Automatic engine deceleration
 - Auto Idle Stop (AIS)
 - Batteries (2 x 12V - 92Ah)
 - Starting motor (24V - 5 kW), 50 amp alternator
 - Automatic engine shut-down for low engine oil pressure
 - Engine oil pan drain valve
 - Double element air cleaner
- CONTROL**
- Working mode selector (H-mode, S-mode)
 - Power Boost
- SWING SYSTEM & TRAVEL SYSTEM**
- Swing rebound prevention system
 - Straight propel system
 - Two-speed travel with automatic shift down
 - Grease-type track adjusters
 - Automatic swing brake
- MIRRORS & LIGHTS**
- Four rearview mirrors
 - Two front working lights
- CAB & CONTROL**
- Two control levers, pilot-operated
 - Tow eyes
 - Horn, electric
 - Integrated left-right slide-type control box
 - Ashtray
 - Cigarette lighter
 - Cab light (interior)
 - Coat hook
 - Luggage tray
 - Large cup holder
 - Detachable two-piece floor mat
 - 7-way adjustable suspension seat
 - Retractable seatbelt
 - Headrest
 - Heater and defroster
 - Intermittent windshield wiper with double-spray washer
 - Skylight
 - Tinted safety glass
 - Pull-type front window and removable lower front window
 - Easy-to-read multi-display monitor
 - Automatic air conditioner
 - Emergency escape hammer
 - Radio, AM/FM Stereo with speakers

OPTIONAL EQUIPMENT

- Dozer blade
- Wide range of buckets
- Wide range of shoes
- Boom safety valve
- Arm safety valve
- Front-guard protective structures (May interfere with bucket action)
- Additional hydraulic circuit
- Cab light
- Control pattern changer (2 way, 4 way)

Note: Standard and optional equipment may vary. Consult your KOBELCO dealer for specifics.

Note: This catalog may contain attachments and optional equipment that are not available in your area. And it may contain photographs of machines with specifications that differ from those of machines sold in your areas. Please consult your nearest KOBELCO distributor for those items you require. Due to our policy of continuous product improvements all designs and specifications are subject to change without advance notice. Copyright by **KOBELCO CONSTRUCTION MACHINERY CO., LTD.** No part of this catalog may be reproduced in any manner without notice.

KOBELCO CONSTRUCTION MACHINERY CO., LTD.

17-1, Higashigotanda 2-chome, Shinagawa-ku, Tokyo 141-8626 JAPAN
Tel: +81 (0) 3-5789-2146 Fax: +81 (0) 3-5789-2135
www.kobelco-kenki.co.jp/english_index.html

Inquiries To:

ACERA GEOSPEC SK225SR/SK225SR^{LC} ROPS-ANZ-201-150301IF

Hydraulic Excavators

ACERA GEOSPEC

SK225SR SK225SR^{LC}

- Bucket Capacity:
0.51- 0.93 m³ ISO heaped
- Engine Power:
118 kW (160 PS)/2,000 min⁻¹ {rpm}
(ISO14396)
- Operating Weight:
22,500 kg – SK225SR
22,900 kg – SK225SR^{LC}



We Save You Fuel
Achieving a Low-Carbon Society

Powerful, Agile and Quiet.



New Performance Capabilities with a Small Rear Swing

The rounded form says it all: an excavator built with a tiny rear swing for maximum maneuverability. But KOBELCO has taken this concept one step further by seeing just how much digging performance can be packed into a machine. It's not the compact design that matters so much as the performance and functions that are actually used on site. And that's just where the new SR Series really shines, thanks to our NEXT-3E concept. So much so, in fact, that the SK225SR and other members of the series bear the same Acera Geospec name as our line of full-size excavators. Thanks to key iNDr technology, we've realized a whole new level of quiet operation, backed by a next-generation power plant that pushes performance to extraordinary new heights. Nine years after developing groundbreaking machines with tiny rear swings, KOBELCO continues to forge ahead as the leader in the field.

NEXT-3E



Pursuing the "Three E's"
The Perfection of Next-Generation,
Network Performance

Enhancement

Greater Performance Capacity

- New hydraulic circuitry minimizes pressure loss
- High-efficiency, electronically controlled Common Rail Fuel Injection Engine
- Powerful travel and arm/bucket digging force

Economy

Improved Cost Efficiency

- Advanced power plant that reduces fuel consumption
- Easy maintenance that reduces upkeep costs
- High structural durability and reliability that retain machine value longer

Environment

Features That Go Easy on the Earth

- Newly developed iNDr technology reduces operational noise
- Meets the latest exhaust emissions standards
- Auto Idle Stop as standard equipment

ACERA
GEOSPEC ACERA GEOSPEC

The "GEO" in GEOSPEC expresses our deep respect for our planet, and for the solid ground where excavators are in their element. This is accompanied by SPEC, which refers to the performance specifications needed to get the job done efficiently as we carry on the tradition of the urban-friendly ACERA series.

iNDR

Integrated
Noise & Dust
Reduction
Cooling System

Amazingly Quiet!

Effective Dust Protection!

Remarkable Ease of Maintenance!



iNDR Filter
Air intake
Exhaust outlet
Closed-structure engine compartment

* Not completely sealed

The iNDR Revolution

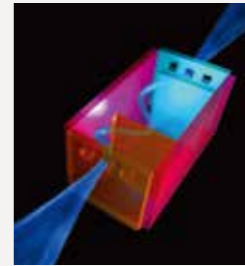

•Concept
KOBELCO has developed the revolutionary integrated Noise and Dust Reduction Cooling System, with the engine compartment placed inside a single duct that connects the air intake to the exhaust outlet.



•Reduces Noise
The intake and exhaust are offset, with the holes and joints in the sections corresponding to the duct wall completely covered to reduce noise at the intake and exhaust apertures. This design, plus the generous use of insulation-material inside the duct, minimizes engine noise.



iNDR Filter

•Reduces Dust
The high-performance iNDR filter removes dust from intake air, ensuring a quieter, cleaner engine and keeping the cooling unit free of clogging so that no regular cleaning is necessary.

Far Surpassing Legal Requirements

The SR series has broken through to a new frontier in quiet operation, with a noise level a full 5 dB below the Japanese government's requirements for ultra-low-noise machinery. In fact, compared with previous KOBELCO models, we have achieved a 10 dB reduction on the right-side surface of the machine, a difference that is clearly audible.

“Ultimate”-Low Noise Level of 95dB(A)

iNDR Filter Improves Operational Reliability



The stainless-steel filter is extremely effective against dust, with a 60-mesh wave-type screen that removes tiny dust particles from the intake air. This not only helps to keep the cooling unit and air cleaner running in top form, but also maintains ideal heat balance.

* "60-mesh" means that there are 60 holes formed by horizontal and vertical wires in every square inch of filter.

Cooling Unit Requires No Regular Cleaning

Because the iNDR filter removes dust from the intake air, no dust gets into block the cooling components, so that no regular cleaning is necessary. The filter can be removed easily without tools and is installed in parallel with the intercooler, radiator, and oil cooler for easy access.

The GEOSPEC Difference:

More Work with Less Fuel !

Amazing Productivity with a 15~21% Decrease in Fuel Consumption and "Top-Class" Cost Performance

Fuel Consumption and Work Volume (New S-mode)

	Vs Previous SK225SR in H-mode	Vs Previous SK225SR in S-mode
Fuel Consumption (L/h)	21% decrease	15% decrease
Work volume per liters of fuel (m³/L)	28% increase	13% increase

"Top-Class" Powerful Digging

Max. arm crowding force **88 kN** {8.98 tf}
 With power boost: **96.8 kN** {9.88 tf}

Max. bucket digging force **120 kN** {12.2 tf}
 With power boost: **132 kN** {13.46 tf}

Powerful Travel

Travel torque: increased by **6 %**
 Drawbar pulling force: **226.9 kN** {23.2 tf}

Greater Swing Power, Shorter Cycle Times

Swing torque: **71.0 kN**
 Swing Speed: **13.3 min⁻¹**

Significant Extension of Continuous Working Hours

The combination of a large capacity fuel tank and excellent fuel efficiency delivers an impressive max. 34% increase in continuous operation hours.*

Fuel tank: **300 L**

Light Lever Operation

Lighter levers mean less operator fatigue over long hours of operation.

10 % Less



A Low, Solid Center of Gravity

Despite their new, heavy-duty attachments, these machines are more stable than their predecessors, resulting in wider working ranges and a digging height equal to or greater than full-sized machines (SK200-8).

Max. digging height: **10,570 mm**

Max. digging reach: **9,710 mm**

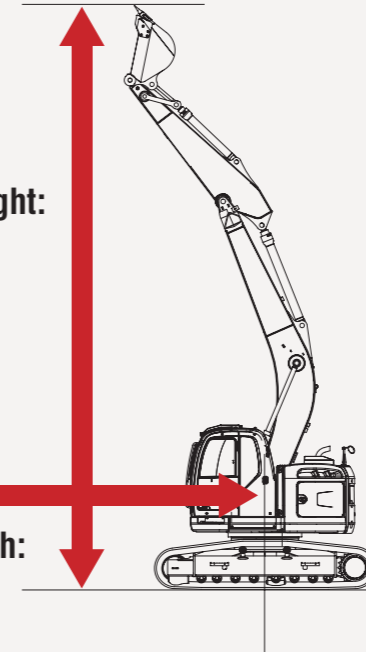

1 NEXT-3E Technology New Hydraulic System



Rigorous inspections for pressure loss are performed on all components of the hydraulic piping, from the spool of control valve to the connectors. This regimen, combine with the use of a new, high-efficiency pump, cuts energy loss to a minimum.

2 NEXT-3E Technology Next-Generation Electronic Engine Control

The high-pressure, common-rail fuel-injection engine features a cooled EGR (Exhaust Gas Recirculation) device that lowers the air intake temperature to keep the oxygen concentration down. The multiple injection system features adjustable control to maximize fuel efficiency and provide powerful medium/low-speed torque. The result is a highly fuel-efficient engine that greatly reduces emissions of PM (Particulate Matter) and NOx into the atmosphere.

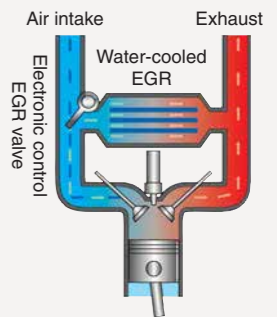

3 NEXT-3E Technology Total Tuning Through Advanced ITCS Control

The next-generation engine control is governed by a new version of ITCS, which responds quickly to sudden changes in hydraulic load to ensure that the engine runs as efficiently as possible with a minimum of wasted output.

ITCS ITCS (Intelligent Total Control System) is an advanced, computerized system that provides comprehensive control of all machine functions.

Simple Select: Two Digging Modes

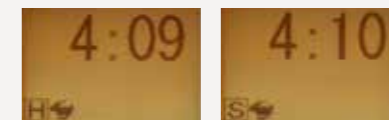

H-Mode For heavy duty when a higher performance level is required. **S-Mode** For normal operations with lower fuel consumption.

Optional N&B (crusher and breaker)
 The operator selects the desired mode from inside the cab, and the selector valve automatically configures the machine accordingly.

Attachment Mode Selector Switch NEW!
 There's a choice of three different hydraulic circuits, to accommodate bucket, crusher or breaker, and the desired attachment mode can be selected with a switch, which automatically configures the selector valve. All attachment modes can be used in either S-mode or H-mode.

Seamless, Smooth Combined Operations

The GEOSPEC machines have inherited the various systems that make inching and combined operations easy and accurate, with further refinements that make a good thing even better. Leveling and other combined operations can be carried out graceful ease.

- Electronic active control system
- Arm regeneration system
- Boom lowering regeneration system
- Variable swing priority system
- Swing rebound prevention system

* The value shows results from actual measurements taken by KOBELCO continuous operation in S Mode, compared with previous model, SK225SR-IES. Results will vary depending on operating method and load conditions.

The GEOSPEC Difference:

Rugged Durability That Ensures Long-Term Machine Value!

Durability That Retains Machine Value Five and Ten Years in the Future

- Improved heat resistance in the swing motor, cylinders and other hydraulic components
- New operator's seat covered by durable material

Highly Reliable ITCS

The manufactured quality of the ITCS controller has been further upgraded, with special measures taken to protect against water and dust. Improvements have also been made in the specs of the pressure sensors, as well as anti-noise performance.



The GEOSPEC Difference:

Designed to Operate Effectively in Close Quarters!

Watch the Job in Front, Not the Counterbalance

The tail of the upper body extends very little past the back end of the crawlers so that the operator can concentrate on the job at hand instead of worrying about the position of the counterweight. This not only improves operating efficiency but reduces costs associated with collision damage.

Requires Less Than 4m of Working Space

The compact design allows the machine to perform continuous 180° dig, swing and load operations within a working space of just 4.0 m.



***Working radius** equals the sum of the minimum forward swing radius and tail swing radius.

The GEOSPEC Difference:

Designed for the Environment and the Future!

Meets Standard Values Set by Emissions Regulations

The engine used in the GEOSPEC machines represents the crystallization of various cutting-edge technologies that minimize the emission of PM (Particulate Matter), NOx, black smoke, and other emissions, thus meeting all internationally recognized environmental regulations, including US EPA Tier III, NRMM (Europe) Stage IIIA, and Act on Regulation, Etc. of Emissions from Non-road Special Motor Vehicles (Japan).

Auto Idle Stop Provided as Standard Equipment

This function saves fuel and cuts emissions by shutting down the engine automatically when the machine is on stand by. It also stops the hourmeter, which helps to retain the machine's asset value.

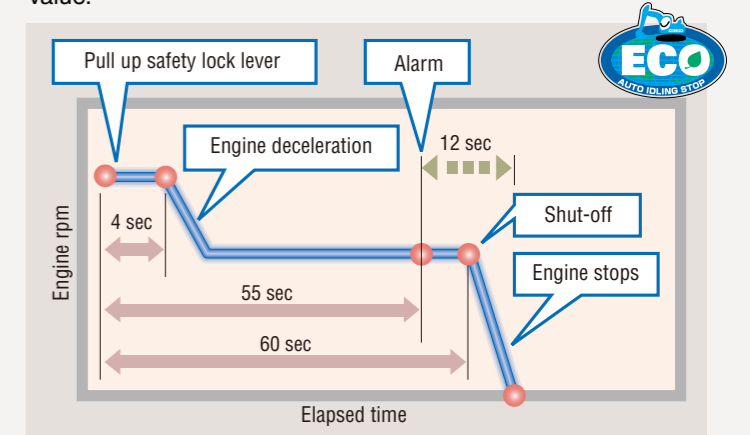

Automatic Acceleration/Deceleration Function Reduces Engine Speed

Engine speed is automatically reduced when the control lever is placed in neutral, effectively saving fuel and reducing noise and exhaust emissions. The engine quickly returns to full speed when the lever is moved out of neutral.

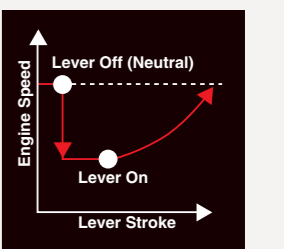

Mild Operating Sound

The iNDr cooling system also helps to keep the machine quiet, even at close quarters. Even the hydraulic relief valves have been designed specifically to reduce irritating noise during operation.

Meets EMC (Electromagnetic Compatibility) Standards in Europe.

Electrical shielding ensures that the machines clear all European standards and neither cause or are affected by electromagnetic interference.

The GEOSPEC Difference:

Fast, Accurate and Low-Cost Maintenance!

Comfortable "On the Ground" Maintenance

All of the components that require regular maintenance are laid out for easy access, with the control valves located on a single right-hand panel that opens and closes at a touch. Behind that, in the pump compartment, there is remote access to such components as the engine oil filter and fuel filter (with built-in water separator). On the left side are the iNDr filter, air cleaner, radiator coolant, etc. Daily maintenance can be carried out easily without the need to climb up onto the machine.



● Easy access to cooling units
Left side



Radiator reservoir tank

● Easy access to pump & filters
Right side



New fuel filter
Engine oil filter

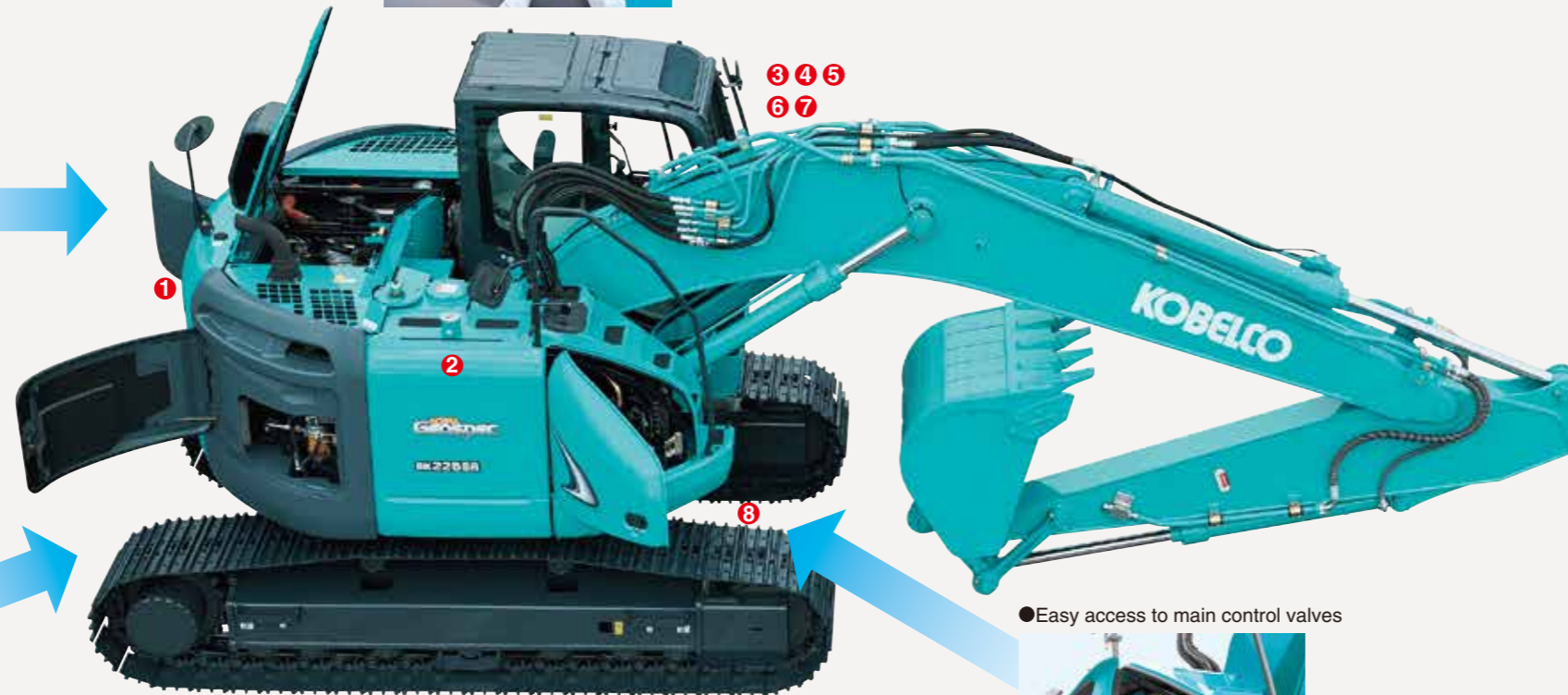

● Easy access to main control valves



Control valve

Fast Maintenance



● Engine quick drain valve can be turned without tools.



● Fuel tank equipped with bottom flange and large drain valve.



● Hour meter can be checked while standing on the ground.



● Easy-access fuse box. More finely differentiated fuses make it easier to locate malfunctions.



● Starter easily replaced from the pump side
● Engine oil filter

● Washer fluid tank located under the cab floor mat.

Easy Cleaning



● Detachable two-piece floor mat with handles for easy removal. A floor drain located under floor mat



● Internal and external air conditioner filters can be easily removed without tools for cleaning



● Special crawler frame designed is easily cleaned of mud

iNDr Means Easy Maintenance

iNDr Filter Blocks Out Dust



Outside air goes directly from the intake duct through the iNDr filter for dust removal. The filter features a 60-mesh screen, which means it has sixty holes per inch both vertically and horizontally, with a wide front surface area accordion structure that resist clogging.

Visual Checking and Easy Cleaning



When checking and cleaning the cooling system, one must deal with several different components like the radiator, oil cooler and intercooler, which all must be handled in different ways. But with the iNDr filter, there's just one filter in one place. If it looks dirty during start-up inspection, it can be cleaned easily and quickly.

Long-Interval Maintenance



● Long-life hydraulic oil reduces cost and labor.

Super-Fine Filter



High performance, super-fine filter has a 1,000 hour replacement cycle.

● Super-fine filter

Double-Element Air Cleaner

The high-performance air cleaner has twice the capacity and service life of previous air cleaners and is installed behind the iNDr filter for even more effective cleaning performance.

Monitor Display with Essential Information for Accurate Maintenance Checks



● Displays only the maintenance information that's needed, when it's needed.
● Self-diagnostic function that provides early-warning detection and display of electrical system malfunctions.
● Record function of previous breakdowns including irregular and transient malfunction.

Choice of 16 Languages for Monitoring Display

With messages including those requiring urgent action displayed in the local language, users in all parts of the world can work with greater peace of mind.

GEOSCAN

GEOSCAN allows you to use the Internet to manage information from your office for machines operating in all areas. This provides a wide range of support for your business operations.

Direct Access to Operational Status

- Location Data
- Operating Hours
- Fuel Consumption Data
- Graph of Work Content
- Graph of Machine Duty Cycles

Maintenance Data and Warning Alerts

- Machine Maintenance Data

Security System

- Engine Start Alarm
- Area Alarm



The GEOSPEC Difference:

A Working Environment That Helps the Operator Concentrate on the Job at Hand!

New Large Cab



The new 'Big Cab' provides a roomy operating space with plenty of legroom, and the door opens wide for easy entry and exit. As well as giving a wide, open view to the front, the cab has increased window areas on both sides and to the rear, for improved visibility in all directions.

Wide-Access Cab Ensures Smooth Entry and Exit



Easy entry and exit assured with wider cab entry and safety lock lever integrated with mounting for control levers.

Excellent Visibility

The wide open view to the front combines with minimized blind spots around the machine for greater onsite safety. Pillar-free right-hand window further improves visibility.



The photo includes optional pedals for N & B. Suspension seat not shown.

In-Cab Noise is Reduced by 4 dB

Compared with Previous Models

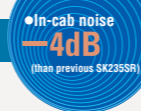

Always Easy to Read! New Information Display



Large analog gauges with large numbers and letters and glare-reducing visors are always easy to read regardless of working conditions.

Comfortable Operating Environment



- Double slide seat
- Powerful automatic air conditioner
- Two-speaker FM/AM radio with station select



- One-touch lock release simplifies opening and closing front window
- Large cup holder
- Spacious luggage tray

ROPS Cab



The newly developed, ROPS (Roll-Over Protective Structure)-compliant cab clears ISO standards (ISO-12117-2:2008) and ensures greater safety for the operator should the machine tip over.

- Level 2 FOPS Guard (ISO 10262) is available as option.
- To fit vandalism guards, please contact your KOBELCO dealer.

Better Visibility Than Ever Before

The wide, open view in front combines with minimized blind spots around the machine for greater onsite safety, with two handrail mirrors, a cab mirror, and a rear mirror on the counterweight providing better visibility than ever before.

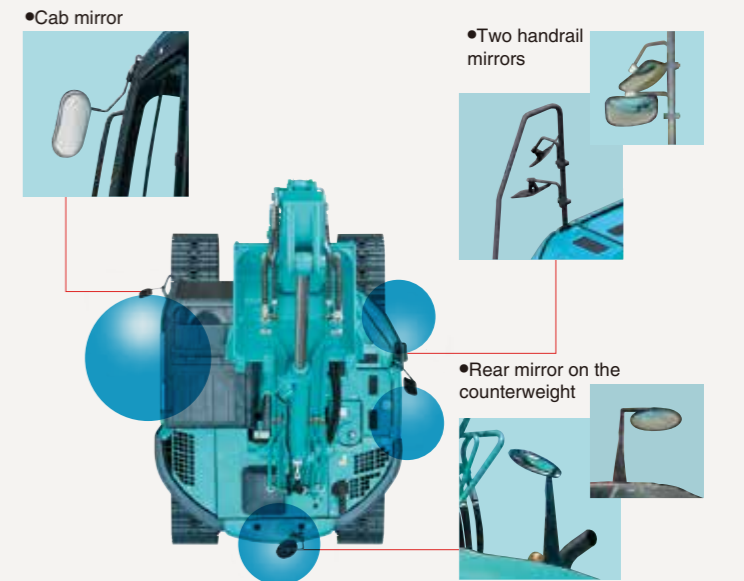

Safety Features That Take Various Scenarios into Consideration



- Firewall separates the pump compartment from the engine
- Hammer for emergency exit
- Handrails meet European standards
- Level indicator that shows degree of machine tilt (optional for NZ)
- Thermal guard prevents contact with hot components during engine inspections
- Retractable seatbelt requires no manual adjustment
- Travel alarm (optional for NZ)

Specifications

Engine

Model	HINO JO5E-TA
Type:	Direct injection, water-cooled, 4-cycle diesel engine with turbocharger, intercooler (Complies with EU (NRMM) Stage IIIA, US EPA Tier III, and act on regulation, etc. of emissions from non-road special motor vehicles (Japan))
No. of cylinders:	4
Bore and stroke:	112 mm x 130 mm
Displacement:	5.123 L
Rated power output:	118 kW /2,000 min ⁻¹ (ISO14396: 2002)* 114 kW /2,000 min ⁻¹ (ISO9249: 2007)
Max. torque:	592 N·m/1,600 min ⁻¹ (rpm) (ISO14396: 2002)* 572 N·m/1,600 min ⁻¹ (rpm) (ISO9249: 2007)

*ISO 14396 meets EU regulation

Hydraulic System





Pump	
Type:	Two variable displacement pumps + 1 gear pump
Max. discharge flow:	2 x 220 L/min, 1 x 20 L/min
Relief valve setting	
Boom, arm and bucket:	34.3 MPa (350 kgf/cm ²)
Power boost:	37.7 MPa (385 kgf/cm ²)
Travel circuit:	34.3 MPa (350 kgf/cm ²)
Swing circuit:	29.0 MPa (296 kgf/cm ²)
Control circuit:	5.0 MPa (50 kgf/cm ²)
Pilot control pump:	Gear type
Main control valves:	8-spool
Oil cooler:	Air cooled type

Swing System

Swing motor:	Axial piston motor
Brake:	Hydraulic; locking automatically when the swing control lever is in the neutral position
Parking brake:	Hydraulic brake
Swing speed:	13.3 min ⁻¹ (rpm)
Tail swing radius:	1,680 mm
Min. front swing radius:	2,340 mm

Attachments

Backhoe bucket and arm combination

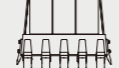
Use	Backhoe bucket					
	Normal diggin				Side pin type	
						
Bucket capacity	(ISO heaped) m ³	0.5	1.07	0.8	0.93	0.8
	(Struck) m ³	0.39	0.52	0.59	0.67	0.59
Opening width	With side cutter mm	870	1,080	1,160	1,330	1,160
	Without side cutter mm	770	980	1,060	1,230	1,060
No. of bucket teeth		3	5	5	5	5
Bucket weight	kg	520	630	630	710	660
Combinations	2.87 m arm	○	○	◎	○	△

◎ Std. ○ Recommended △ Loading only

Travel System

Travel motors:	2 x axial-piston, two-step motors
Travel brakes:	Hydraulic brake per motor
Parking brakes:	Oil disc brake per motor
Travel shoes:	46 each side (SK225SR) 49 each side (SK225SRLC)
Travel speed:	6.0/3.6 km/h
Drawbar pulling force:	227 kN [23,200 kgf] (ISO 7464)
Gradeability:	70 % (35°)

Cab & Control

Cab	
All-weather, sound-suppressed steel cab mounted on the silicon-sealed viscous mounts and equipped with a heavy, insulated floor mat.	
Control	
Two hand levers and two foot pedals for travel	
Two hand levers for excavating and swing	
Electric rotary-type engine throttle	

Boom, Arm & Bucket

Boom cylinders:	120 mm x 1,355 mm
Arm cylinder:	130 mm x 1,406 mm
Bucket cylinders:	110 mm x 1,064 mm

Refilling Capacities & Lubrications

Fuel tank:	300 L
Cooling system:	22 L
Engine oil:	20.5 L
Travel reduction gear:	2 x 5.3 L
Swing reduction gear:	3.0 L
Hydraulic oil tank:	114 L tank oil level 230 L hydraulic system

Working Ranges

Boom		5.62 m
Arm		Standard 2.87 m
Range		
a - Max. digging reach		9.71
b - Max. digging reach at ground level		9.53
c - Max. digging depth		6.59
d - Max. digging height		10.57
e - Max. dumping clearance		7.7
f - Min. dumping clearance		2.97
g - Max. vertical wall digging depth		5.96
h - Min. swing radius		2.34
i - Horizontal digging stroke at ground level		5.02
j - Digging depth for 2.4 m (8') flat bottom		6.38
Bucket capacity ISO heaped m ³		0.8

Digging Force (ISO 6015)

Arm length	Standard 2.87 m
Bucket digging force	120 (12,240) 132 (13,460)
Arm crowding force	88.0 (8,980) 96.8 (9,880)

*Power Boost engaged.

Dimensions

Arm length	Standard 2.87 m
A Overall length	SK225SR 8,690 SK225SRLC 8,830
B Overall height (to top of boom)	3,130
C Overall width of crawler	SK225SR 2,800 SK225SRLC 2,990
D Overall height (to top of cab)	3,100
E Ground clearance of rear end*	1,030
F Ground clearance*	445

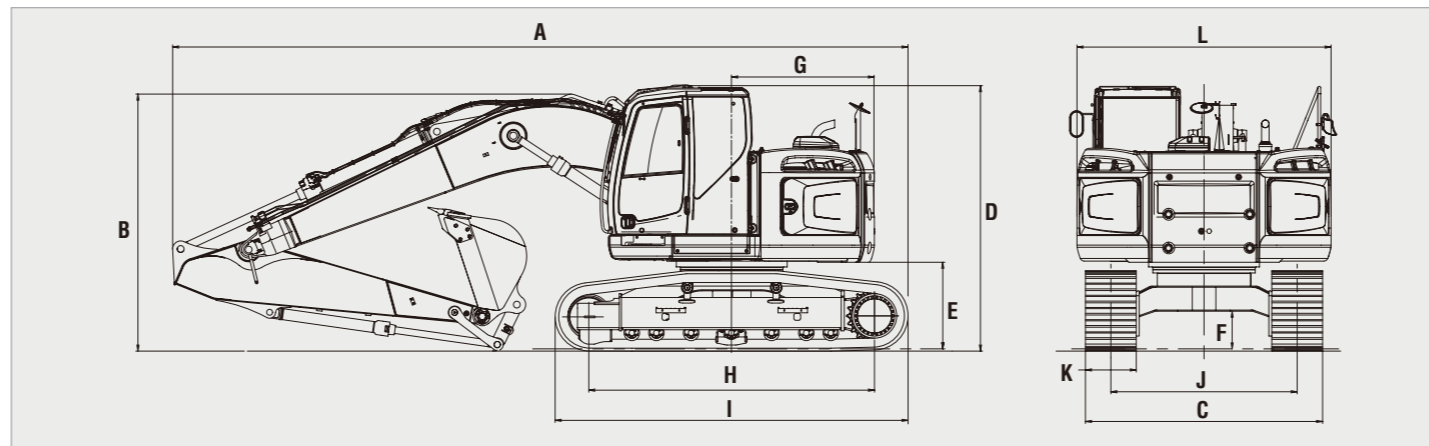

Operating Weight & Ground Pressure

In standard trim, with standard boom, 2.87 m arm, and 0.8 m³ ISO heaped bucket

Shaped	Triple grouser shoes (even height)			
	600	700	800	
Shoe width	mm	600	700	800
Overall width of crawler	mm	2,800 [2,990]	2,900 [3,090]	3,000 [3,190]
Ground pressure	kPa (kgf/cm ²)	50 (0.51) [48 (0.48)]	44 (0.45) [42 (0.42)]	39 (0.40) [37 (0.37)]
Operating weight	kg	22,500 [22,900]	22,900 [23,300]	23,200 [23,600]
Dozer (optional)	Weight	Plus 1,600 kg [-]	Plus 1,600 kg [-]	- [-]
	Ground pressure	Plus 3.6 kPa [-]	Plus 3.1 kPa [-]	- [-]

Lifting Capacities

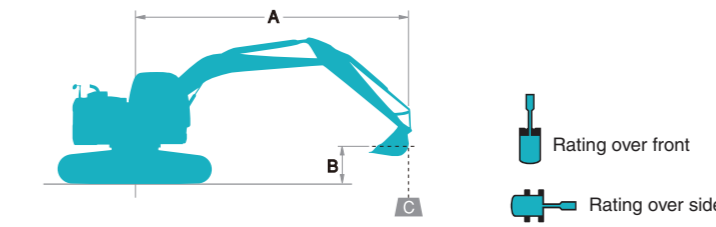

A - Reach from swing centerline to bucket hook
B - Bucket hook height above/below ground
C - Lifting capacities in kilograms
• Max. discharge pressure: 34.3 MPa (350 kgf/cm²)

SK225SR	Standard Arm: 2.87 m Bucket: 0.8 m ³ SAE heaped 630 kg Shoe: 600 mm																		
	A	1.5 m		3.0 m		4.5 m		6.0 m		7.5 m		At max. reach		Radius					
B																			
7.5 m	kg								*2,220	*2,220			*1,900	*1,900	6.15 m				
6.0 m	kg								*3,640	*3,640			*1,800	*1,800	7.27 m				
4.5 m	kg												*1,820	*1,820	7.95 m				
3.0 m	kg								*5,590	*5,590	*4,800	3,800	*2,980	2,510	*1,820	*1,820	8.31 m		
1.5 m	kg								*6,880	*6,880	*8,780	5,100	5,740	4,140	2,390	*1,940	*1,940	8.31 m	
G.L.	kg								*7,270	*7,270	8,810	4,750	5,520	3,070	3,880	2,150	*2,590	1,850	8.19 m
-1.5 m	kg	*6,230	*6,230	*9,810	9,070	8,660	4,620	5,410	2,970	3,830	2,100			*3,350	2,020			7.70 m	
-3.0 m	kg	*9,110	*9,110	*11,310	9,230	*8,080	4,650	5,420	2,980					*4,440	2,450			6.84 m	
-4.5 m	kg													*8,040	3,610			5.45 m	

SK225SR	Standard Arm: 2.87 m Bucket: 0.8 m ³ SAE heaped 630 kg Shoe: 800 mm																		
	A	1.5 m		3.0 m		4.5 m		6.0 m		7.5 m		At max. reach		Radius					
B																			
7.5 m	kg								*2,220	*2,220			*1,900	*1,900	6.15 m				
6.0 m	kg								*3,640	*3,640			*1,800	*1,800	7.27 m				
4.5 m	kg												*1,820	*1,820	7.95 m				
3.0 m	kg								*5,590	5,840	*4,800	3,920	*2,980	2,600	*1,820	*1,820	8.31 m		
1.5 m	kg								*6,880	*6,880	*8,780	5,280	5,940	3,390	4,150	2,350	*2,180	1,920	8.39 m
G.L.	kg								*7,270	*7,270	9,120	4,930	5,720	3,190	4,030	2,240	*2,590	1,930	8.19 m
-1.5 m	kg	*6,230	*6,230	*9,810	9,400	8,970	4,800	5,610	3,090	3,980	2,190			*3,350	2,110			7.70 m	
-3.0 m	kg	*9,110	*9,110	*11,310	9,560	*8,080	4,830	5,620	3,110					*4,610	2,560			6.84 m	
-4.5 m	kg													*4,620	3,750			5.45 m	

SK225SRLC	Standard Arm: 2.87 m Bucket: 0.8 m ³ SAE heaped 630 kg Shoe: 600 mm																		
	A	1.5 m		3.0 m		4.5 m		6.0 m		7.5 m		At max. reach		Radius					
B																			
7.5 m	kg								*2,220	*2,220			*1,900	*1,900	6.15 m				
6.0 m	kg								*3,640	*3,640			*1,800	*1,800	7.27 m				
4.5 m	kg												*1,820	*1,820	7.95 m				
3.0 m	kg								*5,590	5,840	*4,800	3,880	*2,980	2,570	*1,820	*1,820	8.31 m		
1.5 m	kg								*6,880	*6,880	*8,780	5,210	*6,400	3,350	4,620	2,310	*2,180	1,880	8.39 m
G.L.	kg								*7,270	*7,270	*9,380	4,860	6,410	3,140	4,500	2,200	*2,590	1,900	8.19 m
-1.5 m	kg	*6,230	*6,230	*9,810	9,270	*9,140	4,730	6,290	3,050	4,440	2,160			*3,350	2,070			7.70 m	
-3.0 m	kg	*9,110	*9,110	*11,310	9,430	*8,080	4,760	*5,900	3,060					*4,860	2,520			6.84 m	
-4.5 m	kg													*4,620	3,700			5.45 m	

SK225SRLC	Standard Arm: 2.87 m Bucket: 0.8 m ³ SAE heaped 630 kg Shoe: 800 mm																		
	A	1.5 m		3.0 m		4.5 m		6.0 m		7.5 m		At max. reach		Radius					
B																			
7.5 m	kg								*2,220	*2,220			*1,900	*1,900	6.15 m				
6.0 m	kg								*3,640	*3,640			*1,800	*1,800	7.27 m				
4.5 m	kg												*1,820	*1,820	7.95 m				
3.0 m	kg								*5,590	5,960	*5,750	3,750	*4,200	2,550	*1,940	*1,940	8.31 m		
1.5 m	kg								*6,880	*6,880	*8,780	5,400	*6,400	3,480	4,790	2,410	*2,180	1,970	8.39 m
G.L.	kg								*7,270	*7,270	*9,380	5,050	6,650	3,280	4,670	2,310	*2,590	1,990	8.19 m
-1.5 m	kg	*6,230	*6,230	*9,810	9,620	*9,140	4,930	6,530	3,180	4,620	2,260			*3,350	2,170			7.70 m	
-3.0 m	kg	*9,110	*9,110	*11,310	9,780	*8,080	4,960	*5,900	3,190					*4,860	2,630			6.84 m	
-4.5 m	kg													*4,620	3,850			5.45 m	

Notes:

- Do not attempt to lift or hold any load that is greater than these lift capacities at their specified lift point radius and heights. Weight of all accessories must be deducted from the above lift capacities.
- Lift capacities are based on machine standing on level, firm, and uniform ground. User must make allowance for job conditions such as soft or uneven ground, out of level conditions, side loads, sudden stopping of loads, hazardous conditions, experience of personnel, etc.
- Bucket lift hook defined as lift point.
- The above lifting capacities are in compliance with ISO 10567. They do not exceed 87% of hydraulic lifting capacity or 75% of tipping load. Lifting capacities marked with an asterisk (*) are limited by hydraulic capacity rather than tipping load.
- Operator should be fully acquainted with the Operator's and Maintenance Instructions before operating this machine. Rules for safe operation of equipment should be adhered to at all times.
- Lift capacities apply to only machine as originally manufactured and normally equipped by KOBELCO CONSTRUCTION MACHINERY CO., LTD.