

Lift capacities

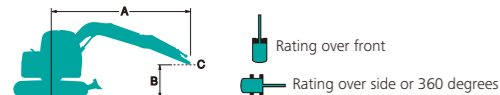

A - Reach from swing centerline to arm top
 B - Arm top height above/below ground
 C - Lift point
 Bucket: Without bucket
 Relief valve setting: 34.3 MPa (350kg/cm²)

SK135SR Offset Boom

SK135SR-7

SK135SR Offset boom		Arm: 2.20 m Bucket: Without Counterweight: 3,150 kg Shoe: 500 mm Dozer: Blade up										
		1.5 m		3.0 m		4.5 m		6.0 m		At Max. Reach		Radius
B	A	Rating over front	Rating over side or 360 degrees	Rating over front	Rating over side or 360 degrees	Rating over front	Rating over side or 360 degrees	Rating over front	Rating over side or 360 degrees	Rating over front	Rating over side or 360 degrees	
6.0 m	kg					*2,650	*2,650			*2,620	*2,620	4.50 m
4.5 m	kg			*4,060	*4,060	*3,580	*3,580			*2,510	2,430	5.64 m
3.0 m	kg			*6,010	*6,010	*4,210	3,340			*2,640	1,960	6.21 m
1.5 m	kg			*8,080	5,280	4,530	2,990	2,900	1,950	2,640	1,770	6.37 m
G. L.	kg			*7,890	4,930	4,270	2,750	2,790	1,850	2,680	1,780	6.15 m
-1.5 m	kg	*6,220	*6,220	*7,790	4,930	4,190	2,690			3,110	2,040	5.52 m
-3.0 m	kg			*6,050	5,150					*4,250	3,020	4.26 m

SK135SR Offset boom		Arm: 2.20 m Bucket: Without Counterweight: 3,150 kg + 580 kg Shoe: 500 mm Dozer: Blade up										
		1.5 m		3.0 m		4.5 m		6.0 m		At Max. Reach		Radius
B	A	Rating over front	Rating over side or 360 degrees	Rating over front	Rating over side or 360 degrees	Rating over front	Rating over side or 360 degrees	Rating over front	Rating over side or 360 degrees	Rating over front	Rating over side or 360 degrees	
6.0 m	kg					*2,650	*2,650			*2,620	*2,620	4.50 m
4.5 m	kg			*4,060	*4,060	*3,580	*3,580			*2,510	*2,510	5.64 m
3.0 m	kg			*6,010	*6,010	*4,210	3,670	3,330	2,310	*2,640	2,180	6.21 m
1.5 m	kg			*8,080	5,860	4,950	3,320	3,180	2,180	2,900	1,980	6.37 m
G. L.	kg			*7,890	5,500	4,680	3,080	3,070	2,070	2,960	2,000	6.15 m
-1.5 m	kg	*6,220	*6,220	*7,790	5,500	4,610	3,010			3,420	2,290	5.52 m
-3.0 m	kg			*6,050	5,720					*4,250	3,370	4.26 m

SK135SR Offset boom		Arm: 2.50 m Bucket: Without Counterweight: 3,150 kg + 580 kg Shoe: 500 mm Dozer: Blade up										
		1.5 m		3.0 m		4.5 m		6.0 m		At Max. Reach		Radius
B	A	Rating over front	Rating over side or 360 degrees	Rating over front	Rating over side or 360 degrees	Rating over front	Rating over side or 360 degrees	Rating over front	Rating over side or 360 degrees	Rating over front	Rating over side or 360 degrees	
6.0 m	kg					*3,170	*3,170			*2,370	*2,370	4.87 m
4.5 m	kg					*3,320	*3,320			*2,280	*2,280	5.93 m
3.0 m	kg			*5,470	*5,470	*3,970	3,720	3,350	2,330	*2,380	2,040	6.48 m
1.5 m	kg			*7,690	5,990	*4,780	3,340	3,190	2,180	*2,660	1,860	6.63 m
G. L.	kg			*8,060	5,490	4,680	3,070	3,050	2,060	2,760	1,860	6.42 m
-1.5 m	kg	*5,630	*5,630	*7,990	5,430	4,570	2,970			3,140	2,100	5.82 m
-3.0 m	kg	*8,960	*8,960	*6,520	5,600	*4,320	3,050			*4,120	2,920	4.65 m

SK135SR Offset boom		Arm: 2.50 m Bucket: Without Counterweight: 3,150 kg + 1,000 kg Shoe: 500 mm Dozer: Blade up										
		1.5 m		3.0 m		4.5 m		6.0 m		At Max. Reach		Radius
B	A	Rating over front	Rating over side or 360 degrees	Rating over front	Rating over side or 360 degrees	Rating over front	Rating over side or 360 degrees	Rating over front	Rating over side or 360 degrees	Rating over front	Rating over side or 360 degrees	
6.0 m	kg					*3,170	*3,170			*2,370	*2,370	4.87 m
4.5 m	kg					*3,320	*3,320			*2,280	*2,280	5.93 m
3.0 m	kg			*5,470	*5,470	*3,970	3,960	*3,380	2,500	*2,380	2,190	6.48 m
1.5 m	kg			*7,690	6,410	*4,780	3,580	3,390	2,350	*2,660	2,010	6.63 m
G. L.	kg			*8,060	5,910	4,980	3,310	3,260	2,220	2,950	2,020	6.42 m
-1.5 m	kg	*5,630	*5,630	*7,990	5,850	4,870	3,210			3,350	2,270	5.82 m
-3.0 m	kg	*8,960	*8,960	*6,520	6,020	*4,320	3,290			*4,120	3,150	4.65 m

- Do not attempt to lift or hold any load that is greater than these lift capacities at their specified lift point radius and heights. Weight of all accessories must be deducted from the above lift capacities.
- Lift capacities are based on machine standing on level, firm, and uniform ground. User must make allowance for job conditions such as soft or uneven ground, out of level conditions, side loads, sudden stopping of loads, hazardous conditions, experience of personnel, etc.
- Arm top is defined as lift point.

- The above lift capacities are in compliance with ISO 10567. They do not exceed 87% of hydraulic lift capacity or 75% of tipping load. Lift capacities marked with an asterisk (*) are limited by hydraulic capacity rather than tipping load.
- Operator should be fully acquainted with the Operator's and Maintenance Instructions before operating this machine. Rules for safe operation of equipment should be adhered to at all times.
- Lift capacities apply to only machine as originally manufactured and normally equipped by KOBELCO CONSTRUCTION MACHINERY CO., LTD.

STANDARD EQUIPMENT

ENGINE

- Engine, ISUZU 4J1XDRAC, Diesel engine with turbocharger and intercooler, Tier IV Final certified
- Auto Idle Stop
- Automatic engine deceleration
- Batteries (2 x 12 V - 80 Ah)
- Starting motor (24 V - 4.0 kW), 50 amp alternator
- Engine oil pan drain cock
- Double element air cleaner

CONTROL

- Working mode selector (H-mode, S-mode and ECO-mode)
- Auger & Breaker piping (proportional hand controlled)
- Extra piping (proportional hand controlled)
- Quick Hitch piping

SWING SYSTEM & TRAVEL SYSTEM

- Swing rebound prevention system
- Straight propel system
- Two-speed travel with automatic shift down
- Sealed & lubricated track links
- 500 mm steel shoes
- Grease-type track adjusters
- Automatic swing brake

MIRRORS, LIGHTS & CAMERAS

- Left side rear view mirror, rear view camera, right and left side view camera
- Three front working lights (LED)

CAB & CONTROL

- Two control levers, pilot-operated
- Horn, electric
- Integrated left-right slide-type control box
- LED door light (interior)
- Coat hook
- Large cup holder
- Detachable two-piece floor mat
- GRAMMER air suspension seat with heater
- Retractable seatbelt
- Headrest
- Handrails
- Intermittent windshield wiper with double-spray washer
- Skylight

- Opening top guard (ISO 10262: 1998)
- Tinted safety glass
- Pull-type front window and removable lower front window
- Easy-to-read 10-inch LCD SCREEN multi-display monitor
- Automatic air conditioner
- Emergency escape hammer
- Radio (AUX & Bluetooth)
- Hands-free telephone
- 12 V converter
- USB port
- Eagle eye view
- Travel alarm

OPTIONAL EQUIPMENT

- Various optional arms
- Wide range of shoes
- Wide range of buckets
- Front-guard protective structure (may interfere with bucket action)
- Pull-type front window and removable lower front window
- Additional counterweight (+580 kg)
- Additional counterweight (+1,000 kg)
- Cab top work LED lights (two lights)
- Mechanical suspension seat
- Rain visor (may interfere with bucket action)
- Additional track guide
- Roll sun shade
- Dozer Blade (for 500mm, 600mm, 700mm shoe)
- Multi control valve

Note: Standard and optional equipment may vary. Consult your KOBELCO dealer for specifics.

Note: This catalogue may contain attachments and optional equipment that are not available in your area. And it may contain photographs of machines with specifications that differ from those of machines sold in your areas. Please consult your nearest KOBELCO distributor for those items you require. Due to our policy of continuous product improvements all designs and specifications are subject to change without advance notice.

Copyright by KOBELCO CONSTRUCTION MACHINERY CO., LTD. No part of this catalogue may be reproduced in any manner without notice.

KOBELCO CONSTRUCTION MACHINERY CO., LTD.

5-15, Kitashinagawa 5-chome, Shinagawa-ku, Tokyo 141-8626 JAPAN
 Tel: +81 (0) 3-5789-2146 Fax: +81 (0) 3-5789-2135
<https://www.kobelcocm-global.com/>

Enquiries To:

SK135SR-7 Offset-ANZ-102-2009XXEF

KOBELCO

Performance X Design

SK135SR Offset Boom

■ Bucket capacity:

0.38 – 0.50 m³

■ Engine power:

71.3 kW/2,000 min⁻¹

■ Operating weight:

15,000 – 17,300 kg

We Save You Fuel
 Achieving a Low-Carbon Society



Performance  Design

With the release of the SK135SR Offset Boom, KOBELCO has completely harmonised the values of PERFORMANCE and DESIGN. The SK135SR delivers greater efficiency and productivity with increased power and speed, along with uncompromising operator comfort and machine operability.

In the pursuit of producing unique and unbeatable machines that provide comfort and productivity without equal, KOBELCO continues to rise to the challenge.

SK135SR

THE ULTIMATE SLEEK AND STYLISH CAB DESIGN

True ergonomic functionality combined with modern design has resulted in a cabin interior that is sleek and comfortable, built for simplicity and operator comfort.

Jog dial

The jog dial integrates multiple functions to allow for simple navigation of machine information screens, even while wearing gloves.

LED backlights

LED backlighting on switches and dials provides a bright, clear view of controls, even in the dark, while delivering a premium look and feel.



UNFORGETTABLE COMFORT

① Air suspension seat

A GRAMMER seat is installed as standard equipment, which achieves excellent shock absorption and superior ride comfort.

② Optimal air conditioning vent placement

Air conditioning vents are optimally placed around the cabin with air flow directed toward the operator's neck and back, providing more comfortable operation.

③ Ergonomic and low-effort pilot control levers

Pilot control levers are mounted on adjustable consoles, with an ergonomic design that allows movement without twisting, reducing operator fatigue.



New Hydraulic Control

Our newly upgraded hydraulic control system responds to shorter lever strokes than current models, delivering swifter, more precise movement and improved lever operability.

④ LED door light

The LED interior light automatically turns on when the door is opened or when the ignition is set to OFF. This ensures easy entry and exit at nighttime.

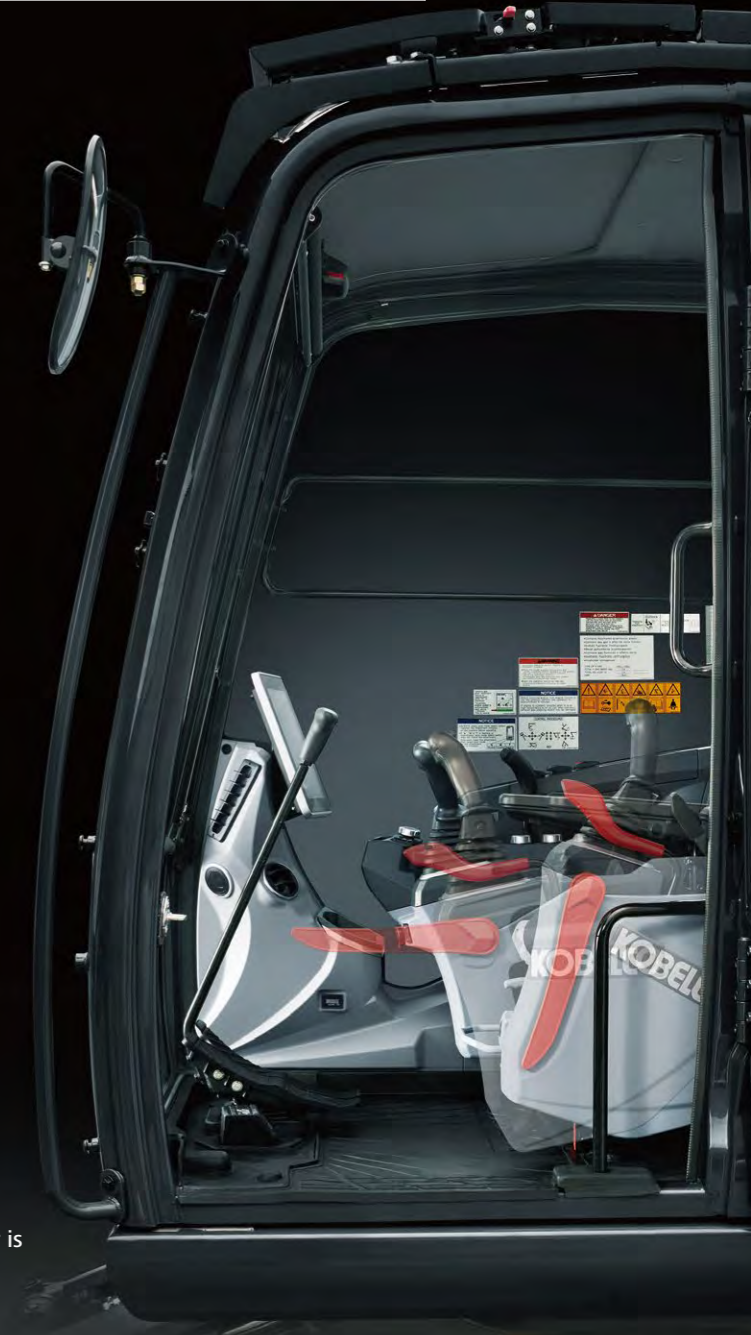



A WIDER VIEW BRINGS A WIDER RANGE OF USE

10-inch colour monitor—the largest in the industry

The easy-to-operate menu screen facilitates easy reading and navigation. Images from the built-in cameras can be checked on the large screen, which helps to improve safety. In addition, each icon is easily recognisable.



The right camera and rear camera (right side view mode)

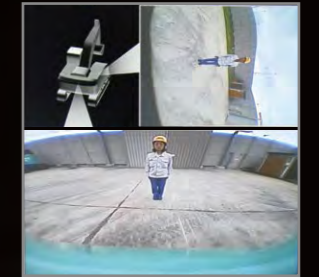

The right camera and rear camera (straight view mode)

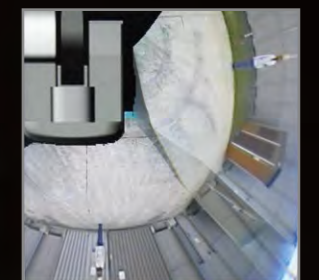

SAFETY ON FULL DISPLAY

Our high-resolution, large display shows right, left and rear side cameras together. Multiple camera modes allow operators to customize their display based on their needs to enhance awareness and jobsite safety.



Screen display linked with the jog dial operation

The jog dial provides simple and intuitive control of all display screens. Turn the jog dial to the right or left to select an item and press the dial to confirm the selection.

THE NEXT LEVEL OF PERFORMANCE

Our high-power engine complies with Tier 4 Final emission regulations

Compared to previous models, the engine output is significantly increased, which shortens the digging cycle time substantially. It attains high performance without reducing the speed even when heavy a load is applied or when travelling on a slope.



Model: ISUZU 4JJ1XDRAC

Engine output

71.3kW/2,000min⁻¹

With fan



Bucket Digging Force

92.9 kN (ISO6015)

Increased by **6%**

(Compared to the SK135SR-5 offset model)

Performance

ADDED CAPABILITIES SMOOTH OUT ANY ROAD PROJECT

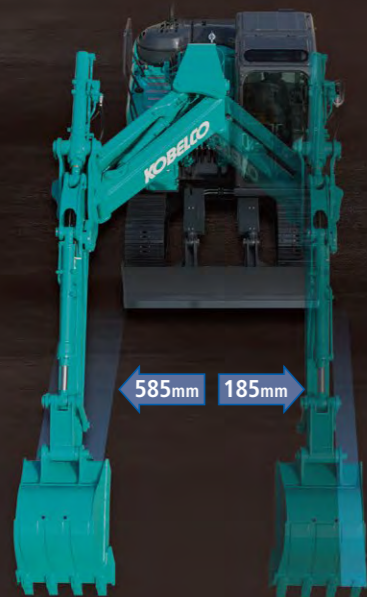

585mm 185mm

Standard equipment includes an offset boom, and a dozer blade makes swift work of excavation next to walls or of side ditches, as well as refilling.

585mm

Digging width at outer edge of right crawler

185mm

Digging width at outer edge of left crawler

Offset boom with hydraulic lines inside the cylinders to prevent damage

The press-constructed boom is both lightweight and slim for smooth operation. The large offset makes it easy to dig right next to walls.



3,360mm

1,870mm 1,490mm

3,360mm

Min. working width

Compact working radius is ideal for road work in close quarters

The operator gets the best of both worlds: a roomy cab fitted on a compact upper body. With such a small working radius, the machine is perfect for continuous digging, swinging, and loading operations in tight spaces.

Smooth rotation cuts cycle times during swinging operation

Thanks to powerful swing torque and fast swing speed, digging, swinging, and loading — continuous operation makes any task faster.

GREATER MULTI-FUNCTION CAPABILITIES

Attachment mode

The flow-rate modes of the bucket, breaker, nibbler, and rotating grapple are set before delivery, which allows you to start operating immediately. Mode settings for other attachments, such as the tilt rotator, can easily be added or changed.

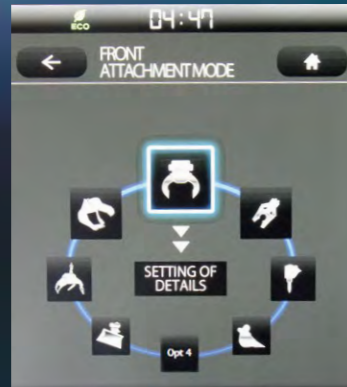

Adjustment for hydraulic flow

Divide ratio of hydraulic flow can be adjusted by service factory for custom usage.



NON-STOP OPERATION BY iNDr

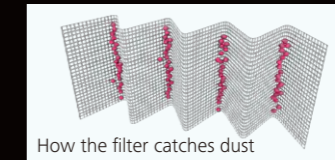
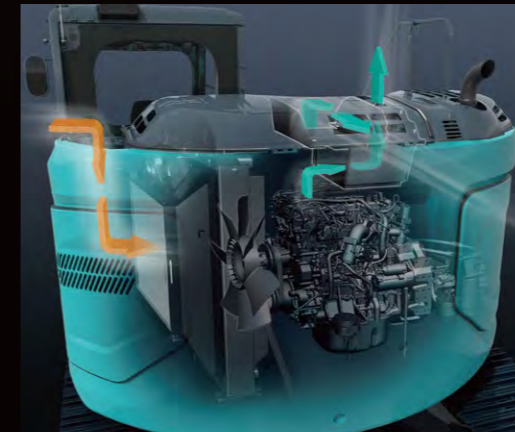

iNDr Filter

A high-density stainless steel mesh filter blocks dust and debris from entering the cooling package during air intake. This prevents the cooling package and air cleaner from clogging, allowing the machine to maintain cooling performance. The ridges of the corrugated filter allow air to pass through, while the grooves collect dust and debris, preventing the filter from clogging.

CONVENIENT AND SENSIBLE EQUIPMENT



Adjustable height pilot control levers
Operator can adjust height of attachment control levers.



AM/FM Bluetooth® (hands-free) radio
Audio streaming and hands free phone calling capability.
*“Bluetooth®” is a registered trademark of the Bluetooth SIG Inc.



USB port / 12V power outlet



Smartphone holder
You can use the holder with your smartphone connected to the USB port.



Opening Top guard
The Top guard is hinged, allowing easy access to the top window for serviceability.



Ground level AdBlue* tank
* AdBlue® is a registered trade mark of the Verband der Automobilindustrie e. V. (VDA).

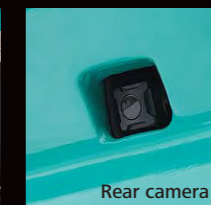

Rear camera

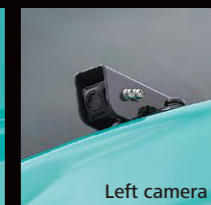

Left camera

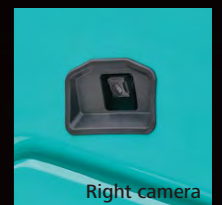

Right camera

Standard built-in rear, left and right side cameras

GEOSCAN

GEOSCAN is the remote monitoring system for SK series excavators. When a hydraulic excavator is fitted with this system, data on the machine's operation, such as operating hours, location, fuel consumption, and maintenance status can be obtained remotely.

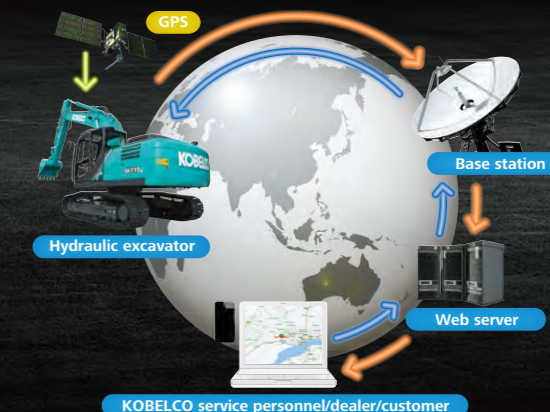

Specifications

Engine

Model	ISUZU 4JJ1XDRAC
Type	Four-cycle, liquid-cooled, direct injection diesel, turbo charged, Tier IV Final certified
No. of cylinders	4
Bore and stroke	95.4 mm x 104.9 mm
Displacement	2,999 L
Rated power output	71.3 kW/2,000 min ⁻¹ (with fan)
	78.5 kW/2,000 min ⁻¹ (without fan)
Max. torque	354 N·m/1,800 min ⁻¹ (ISO 9249: with fan)
	375 N·m/1,800 min ⁻¹ (ISO 14396: without fan)

Hydraulic system

Pump	
Type	Two variable displacement piston pumps + one gear pump
Max. discharge flow	2 x 130 L/min 1 x 20 L/min
	Extra gear pump 1 x 60 L/min
Relief valve setting	
Boom, arm and bucket	34.3 Mpa
Travel circuit	34.3 Mpa
Swing circuit	28.0 Mpa
Control circuit	5.0 Mpa
Pilot control pump	Gear type
Main control valves	13-spool
Oil cooler	Air cooled type

Swing system

Swing motor	One fixed displacement piston motor
Brake	Hydraulic; locking automatically when the swing control lever is in the neutral position
Parking brake	Wet multiple plate
Swing speed	11.0 min ⁻¹
Swing torque	40.4 kN·m

Attachments

Backhoe bucket and combination

Use	Backhoe bucket			
	ISO heaped		Normal digging	
Bucket capacity	struck	m ³	0.38	0.50
	With side cutter	m ³	0.28	0.38
Opening width	With side cutter	mm	800	1,000
	Without side cutter	mm	740	940
No. of teeth			4	5
Bucket weight		kg	340	390
Combination	2.20m standard arm		○	○
	2.50m long arm		◎	×

◎ Standard ○ Recommend △ Loading only × Not recommended

Travel system

Travel motors	Variable displacement piston, two-speed motors
Travel brakes	Hydraulic brake
Parking brakes	Wet multiple plate
Travel shoes	44 each side
Travel speed	3.4 / 5.6 km/h
Drawbar pulling force	140 kN (SAE)
Gradeability	70% (35°)

Cab & control

Cab	
All-weather, sound-suppressed steel cab mounted on the silicon-sealed viscous mounts and equipped with a heavy, insulated floor mat	
Control	
Two hand levers and two foot pedals for travel	
Two hand levers for excavating and swing	
Electric rotary-type engine throttle	

Boom, arm & bucket

Boom cylinders	100 mm x 1,065 mm
Arm cylinder	115 mm x 965 mm
Bucket cylinder	95 mm x 885 mm
Offset cylinder	105 mm x 510 mm

Dozer blade (optional)

Dozer cylinder	125 mm x 220 mm
Dimension	2,490 mm (for 500 mm shoe) (width) x 570 mm (height)*
Working range	500 mm (up) x 590 mm (down)

*Dozer width is changed according to the shoe width difference.

Refilling capacities & lubrications

Fuel tank	186 L
Cooling system	17 L
Engine oil	17 L
Travel reduction gear	2 x 2.1 L
Swing reduction gear	1.65 L
Hydraulic oil tank	89.9 L tank oil level
	186 L hydraulic system
Urea tank	20.7L

Working ranges

Unit: m

Range	Arm	4.37 m					
		2.20 m			2.50 m		
		Max. Left	Center	Max. Right	Max. Left	Center	Max. Right
a- Max. digging reach		7.18	7.60	7.16	7.44	7.86	7.42
b- Max. digging reach at ground level		6.99	7.42	6.98	7.26	7.69	7.24
c- Max. digging depth		4.52	4.92	4.50	4.81	5.22	4.80
d- Max. digging height		7.75	8.09	7.74	7.91	8.25	7.90
e- Max. dumping clearance		5.43	5.77	5.42	5.59	5.93	5.58
f- Min. dumping clearance		2.11	2.44	2.10	1.82	2.15	1.81
g- Max. vertical wall digging depth		2.62	2.94	2.61	2.90	3.23	2.89
h- Min. swing radius		1.88	1.83	2.13	1.93	1.87	2.19
i- Horizontal digging stroke at ground level		3.78	3.76	3.78	4.25	4.22	4.25
j- Digging depth for 2.4 m (8') flat bottom		4.15	4.55	4.13	4.47	4.87	4.45
Bucket capacity ISO heaped m ³		0.45			0.38		

Unit: kN

Arm length	2.20 m	2.50 m
Bucket digging force	92.9	
Arm crowding force	61.9	57.3

Dimensions

Unit: mm

Arm length	2.20 m	2.50 m
A Overall length	7,560	7,580
B Overall height (to top of boom)	2,690	2,740
C Overall width	2,490**	
D Overall height (to top of cab)	2,860	
E Ground clearance of rear end*	870	
F Ground clearance*	400	

G Tail swing radius	1,490
G' Distance from centre of swing to rear end	1,490
H Tumbler distance	2,870
I Overall length of crawler	3,580
J Track gauge	1,990
K Shoe	500
L Overall width of upperstructure	2,480
M Dozer blade (up / down)***	500 / 590

*Without including height of shoe lug **500 mm shoe ***Dozer blade is optional equipment

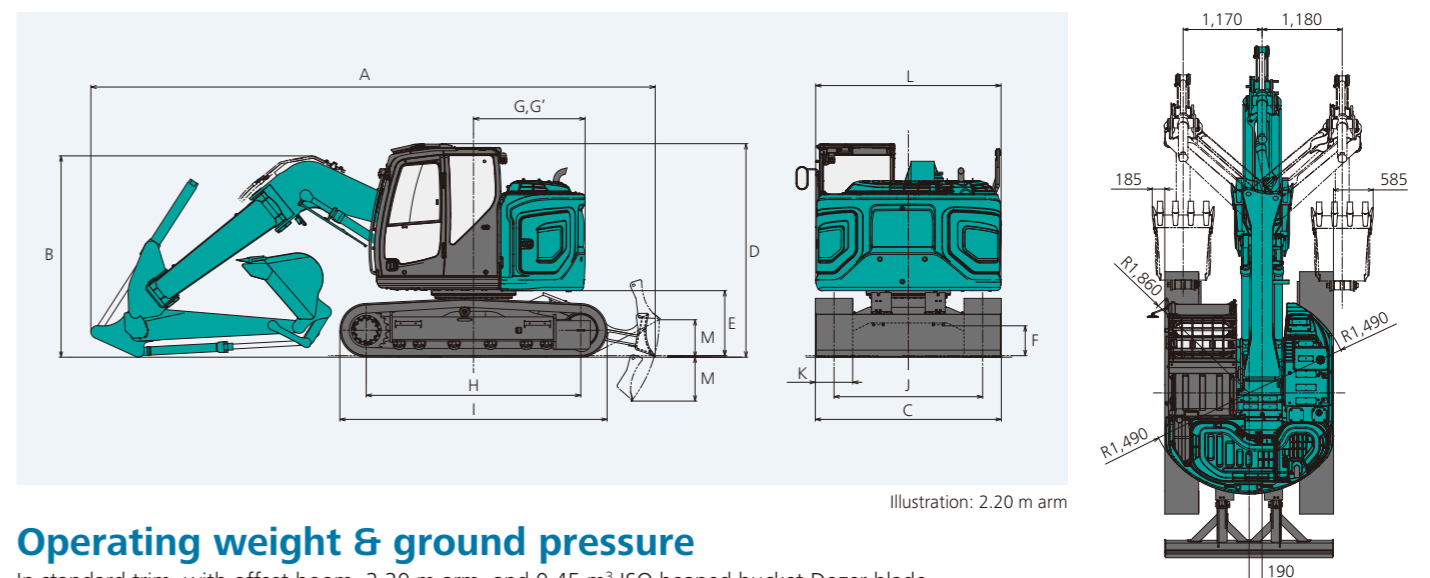

Operating weight & ground pressure

In standard trim, with offset boom, 2.20 m arm, and 0.45 m³ ISO heaped bucket Dozer blade

	Shaped	Triple grouser shoes (even height)	
Shoe width	mm	500	700
Overall width of crawler	mm	2,490	2,690
Ground pressure	kPa	49.6	36.5
Operating weight	kg	15,800	16,300

SK135SR Offset Boom

SK135SR-7

Illustration: 2.20 m arm

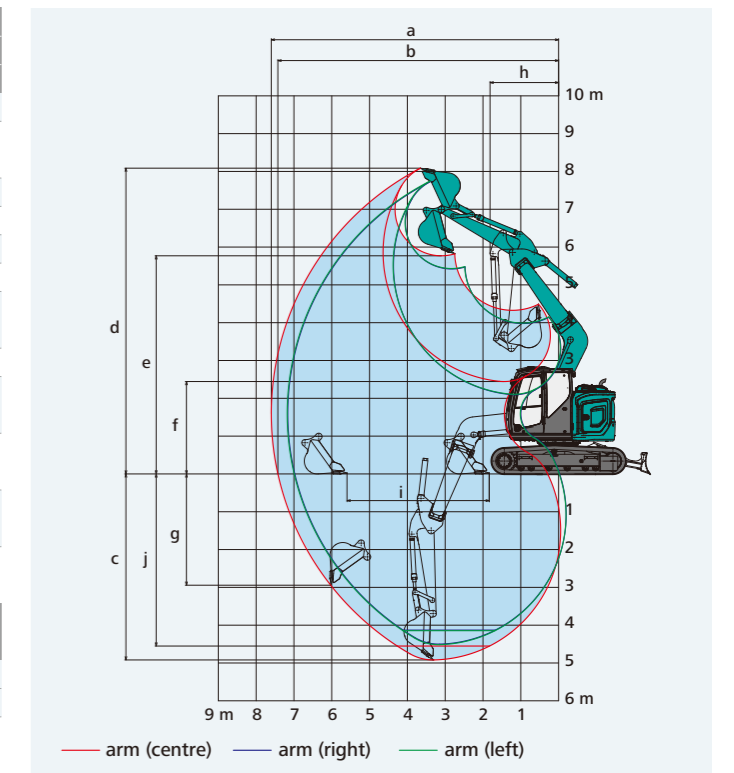

G Tail swing radius	1,490
G' Distance from centre of swing to rear end	1,490
H Tumbler distance	2,870
I Overall length of crawler	3,580
J Track gauge	1,990
K Shoe	500
L Overall width of upperstructure	2,480
M Dozer blade (up / down)***	500 / 590

*Without including height of shoe lug **500 mm shoe ***Dozer blade is optional equipment

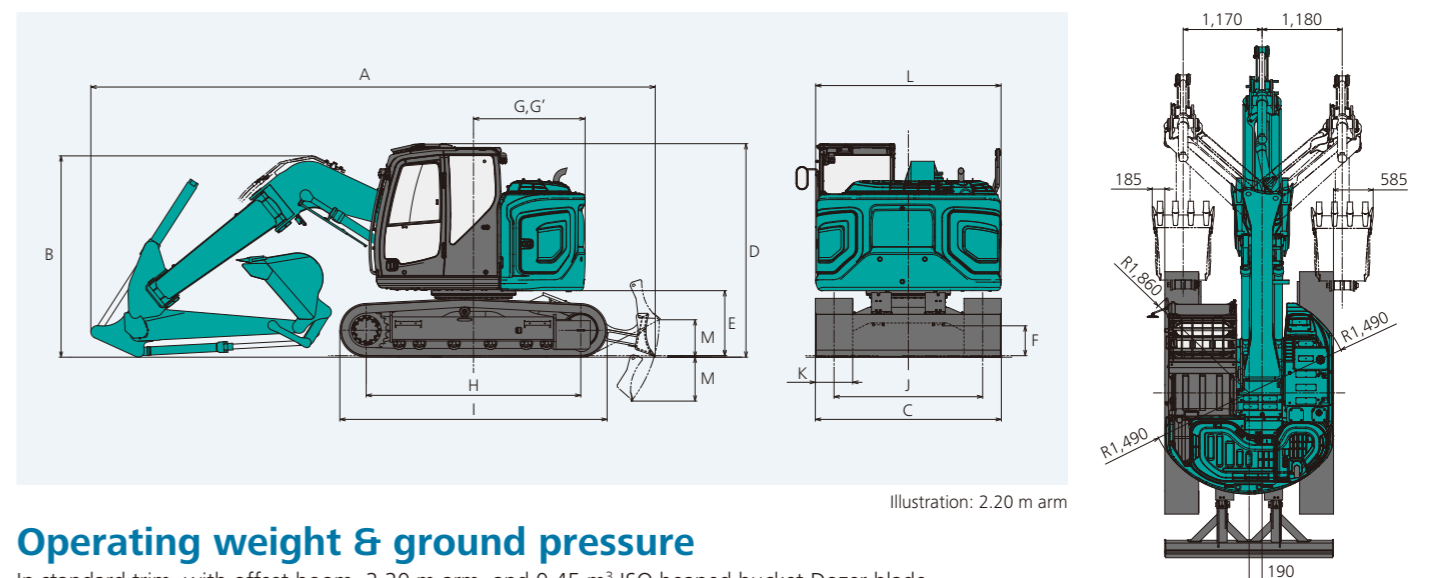

Operating weight & ground pressure

In standard trim, with offset boom, 2.20 m arm, and 0.45 m³ ISO heaped bucket Dozer blade

	Shaped	Triple grouser shoes (even height)	
Shoe width	mm	500	700
Overall width of crawler	mm	2,490	2,690
Ground pressure	kPa	49.6	36.5
Operating weight	kg	15,800	16,300